

**VENTILATOR KLIMA TEHNIKA**

***(B) A V M***

***AKSIJALNI VENTILATOR***

**2016 / 2017**

## (B)AVM ventilatori

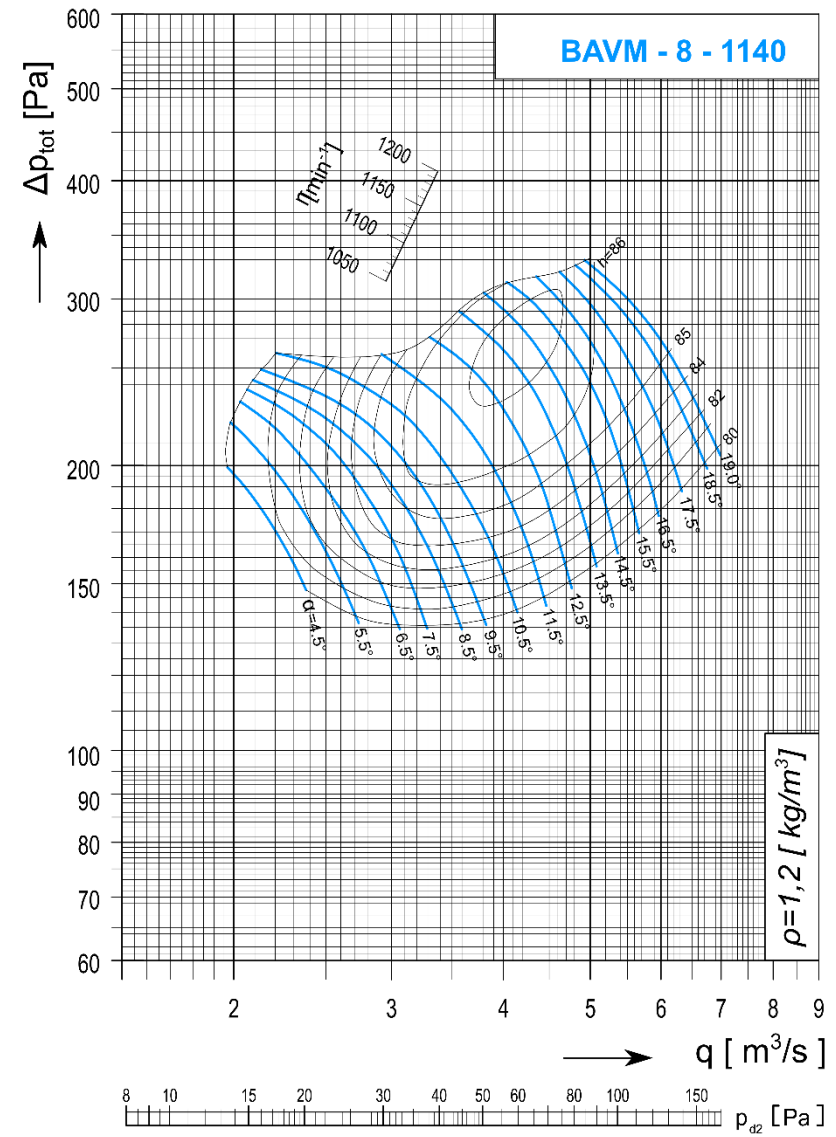
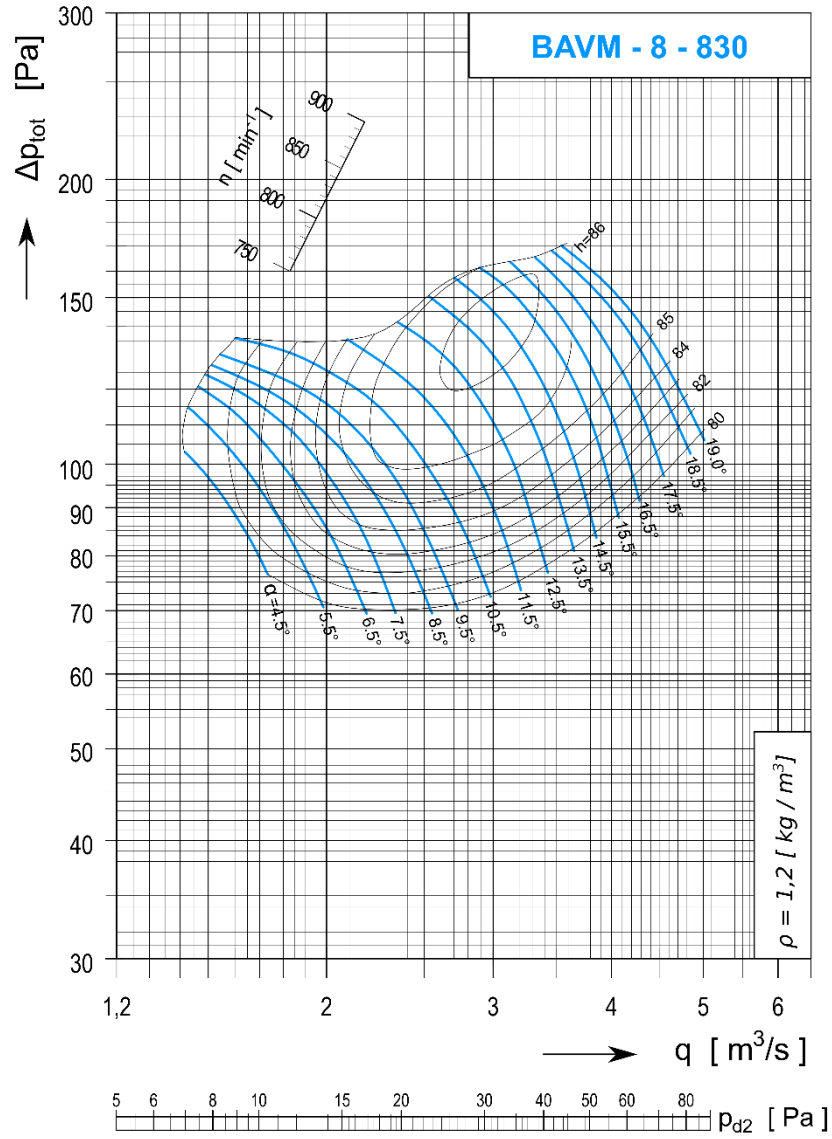

## (B)AVM ventilatori

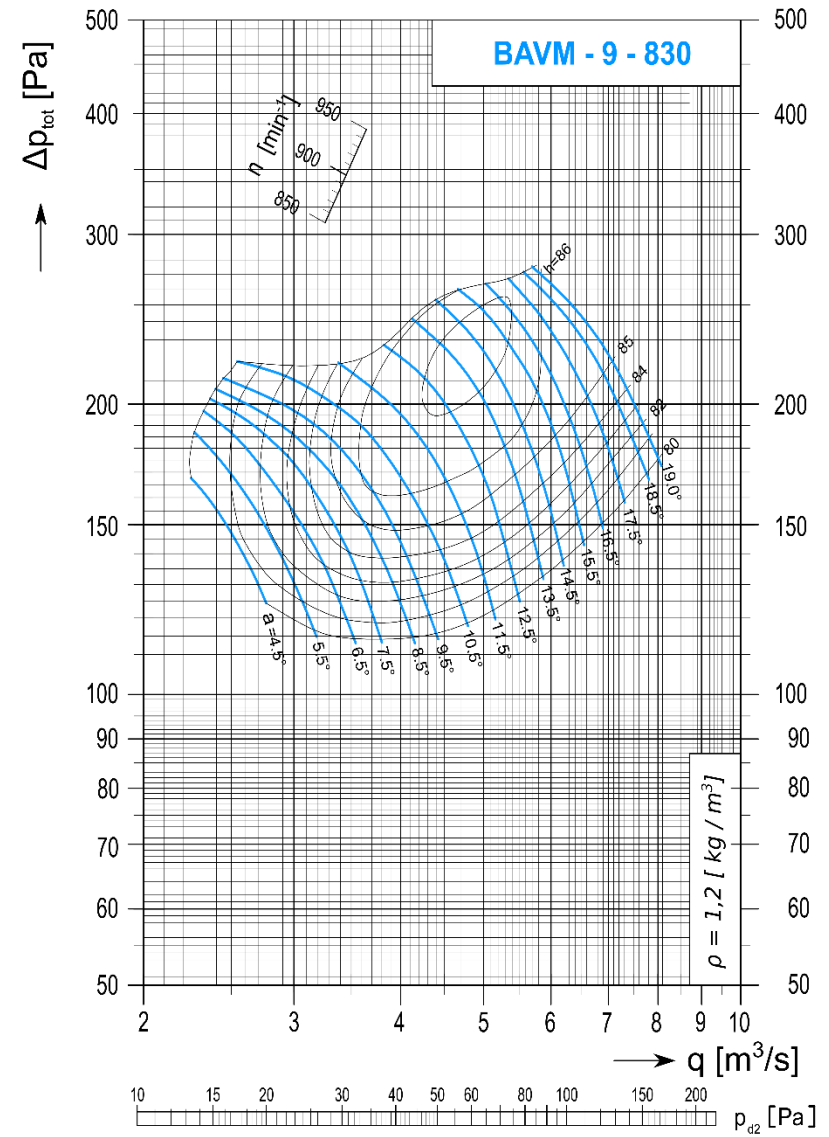
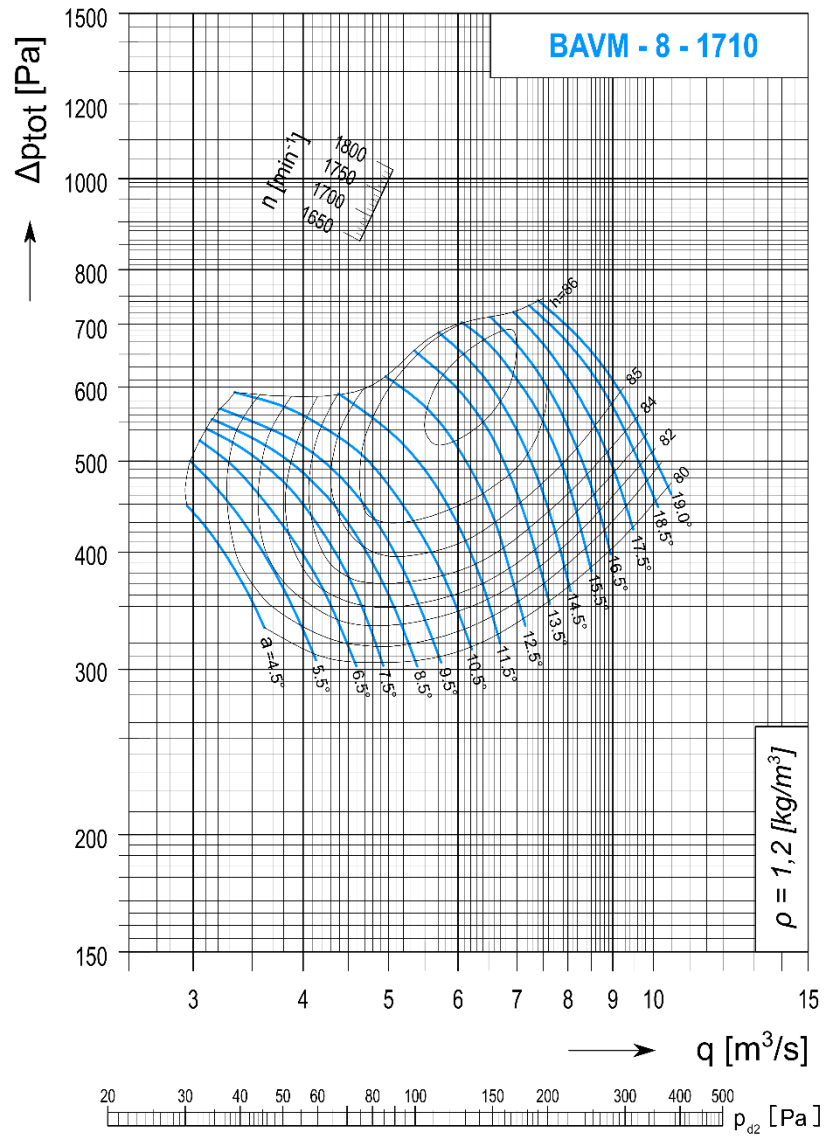

## (B)AVM ventilatori

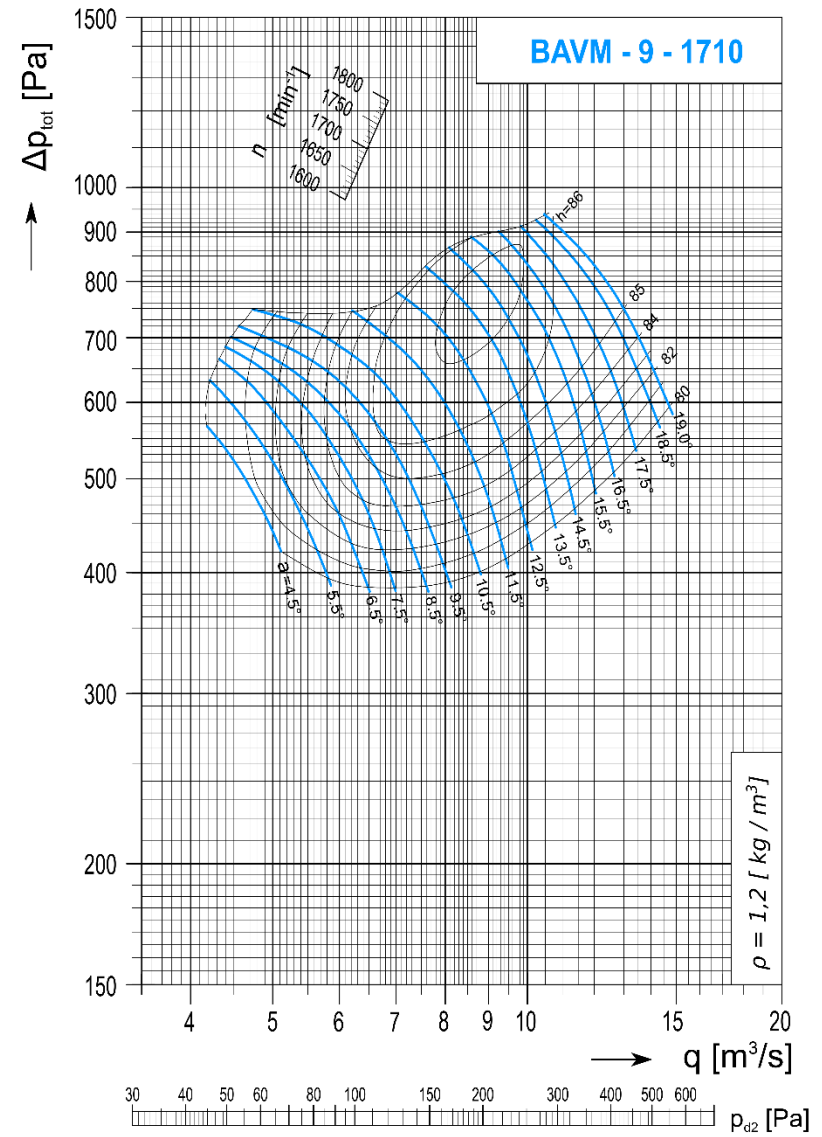
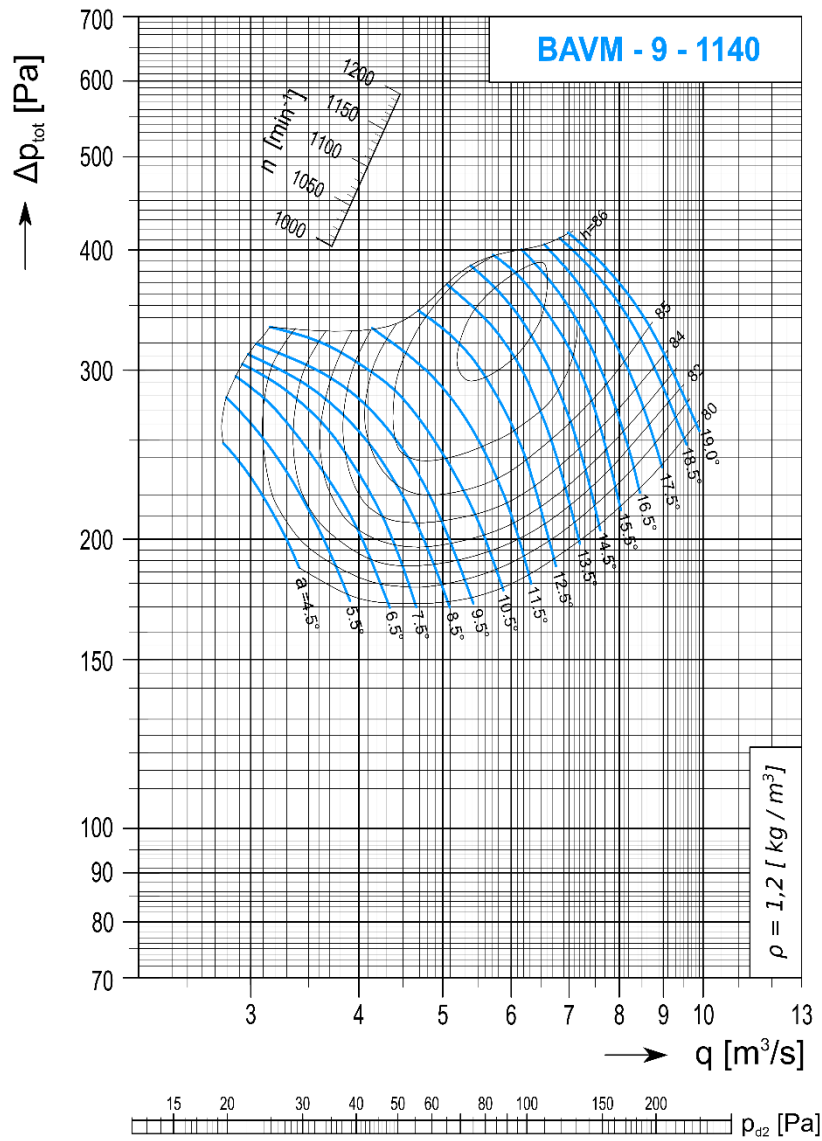

## (B)AVM ventilatori

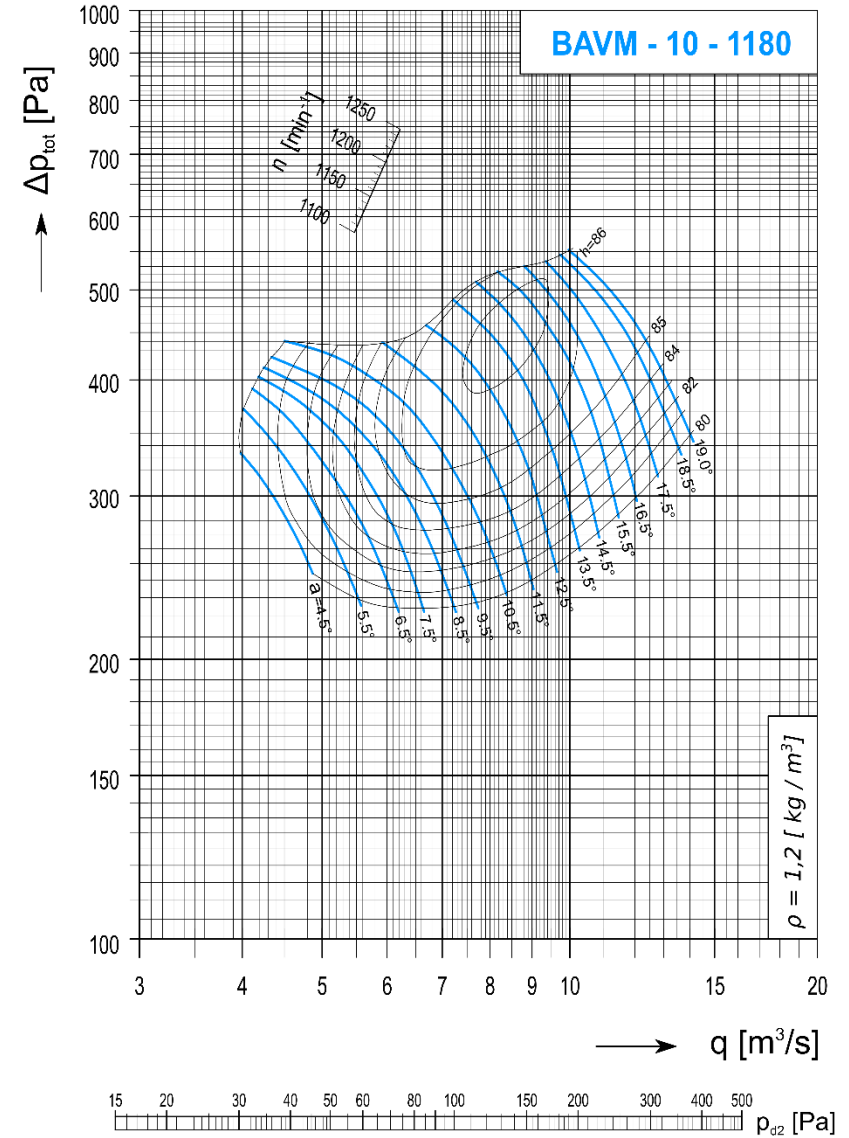
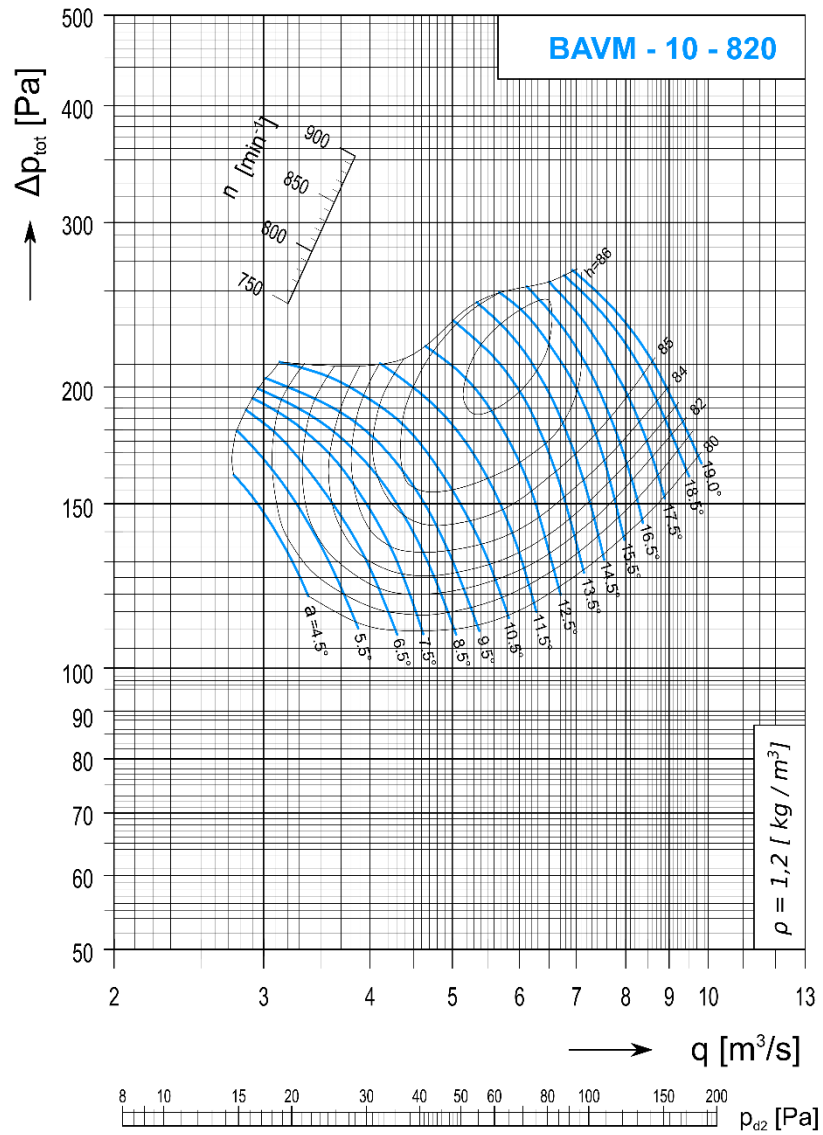

**(B)AVM ventilatori**

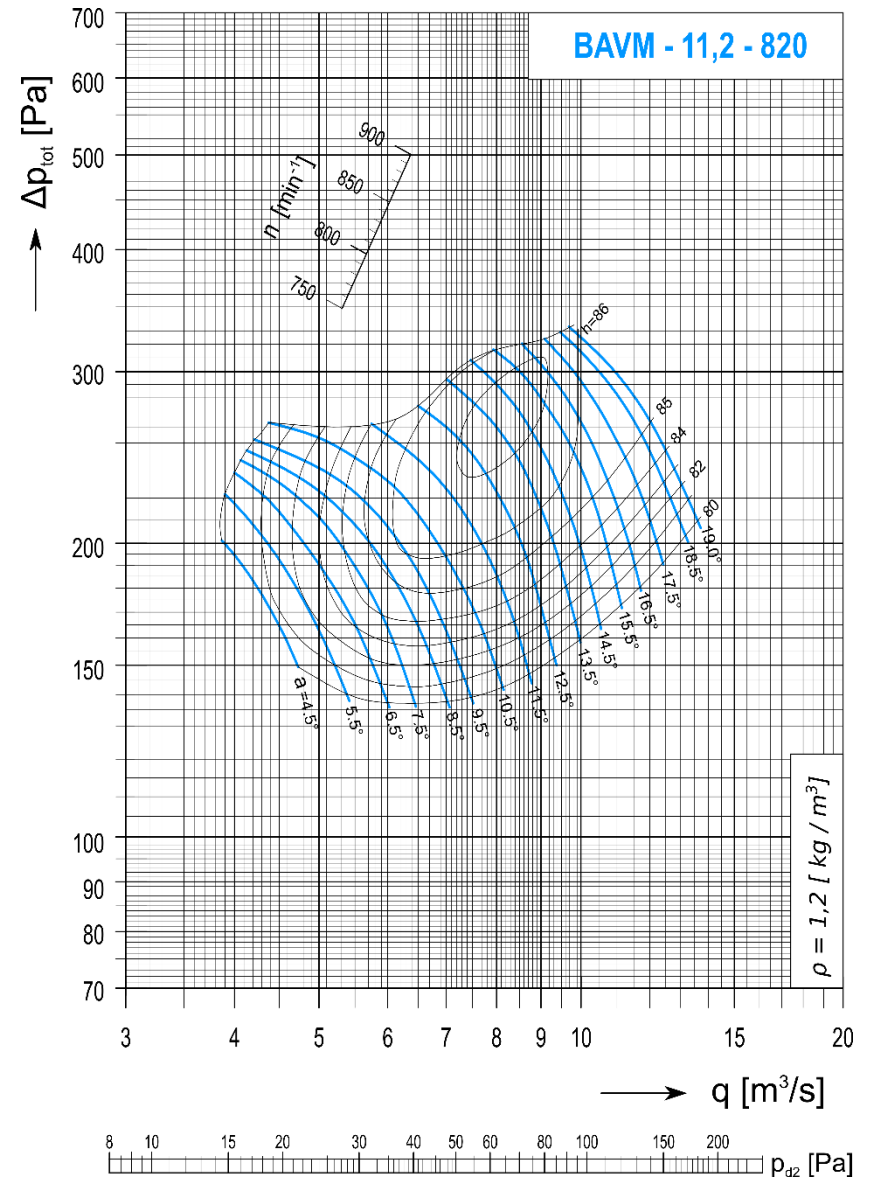
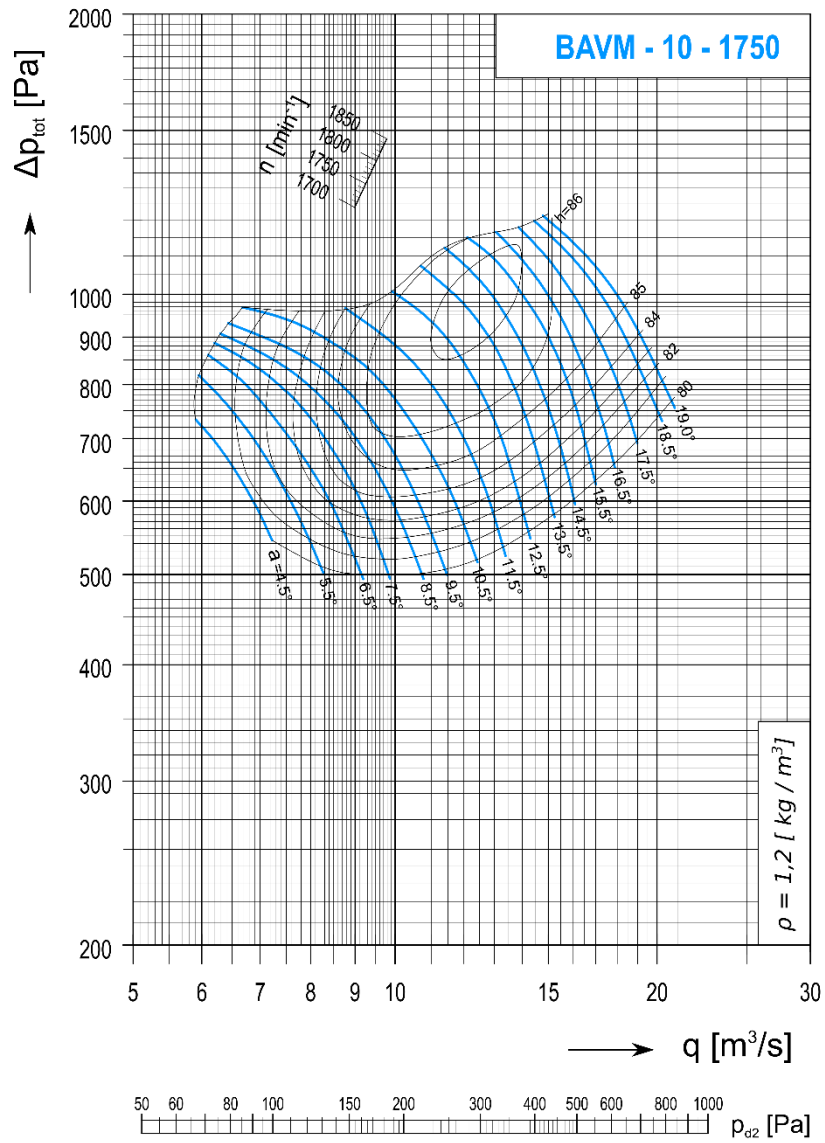

## (B)AVM ventilatori

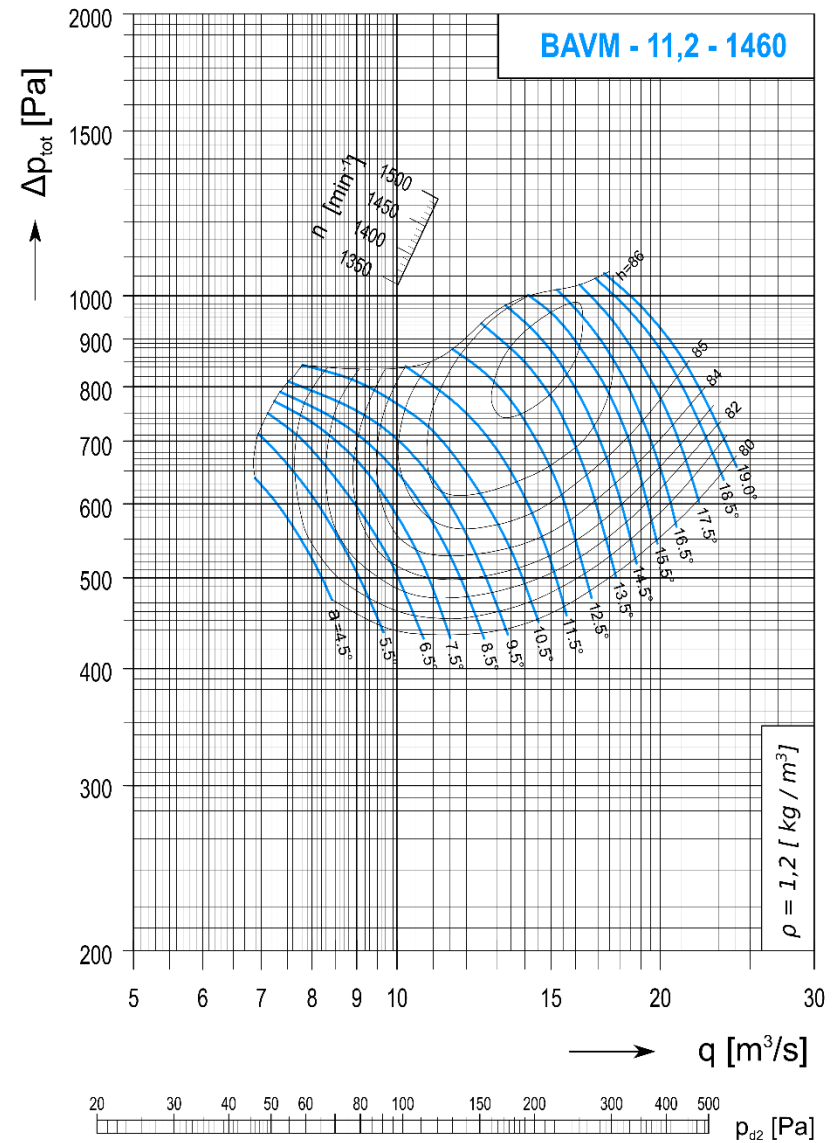
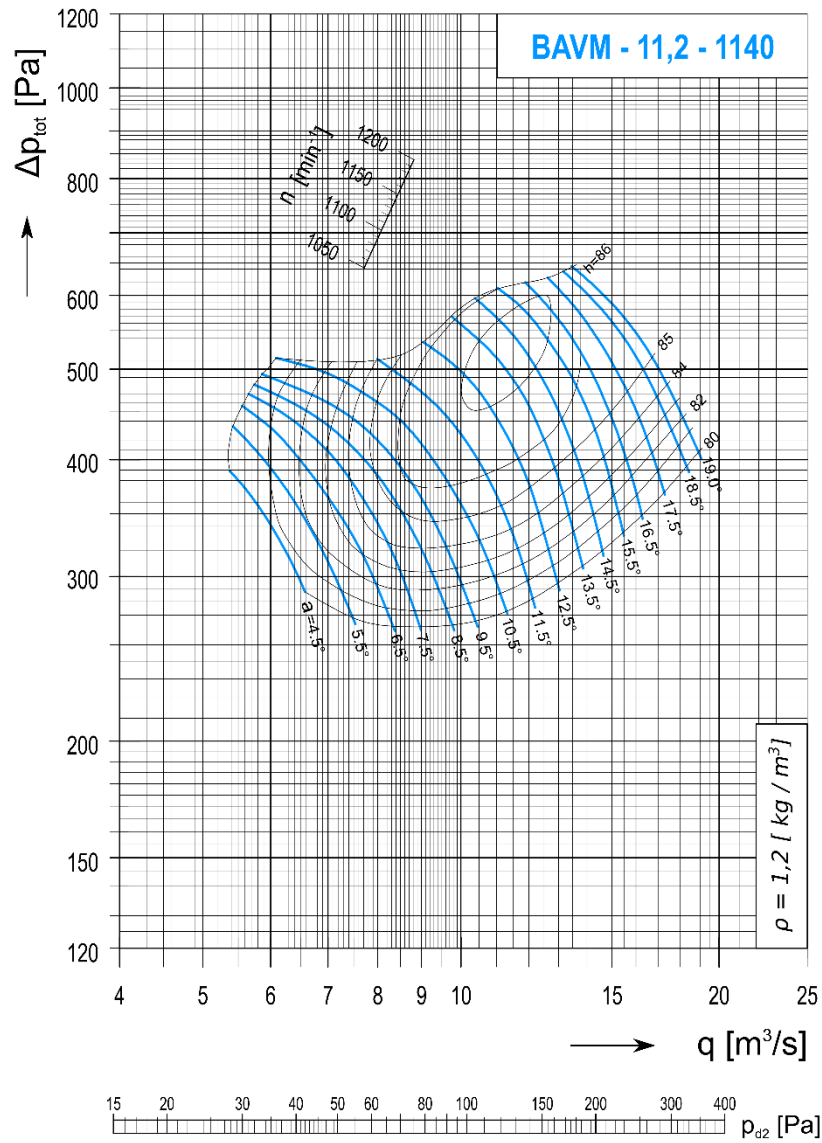



## (B)AVM ventilatori

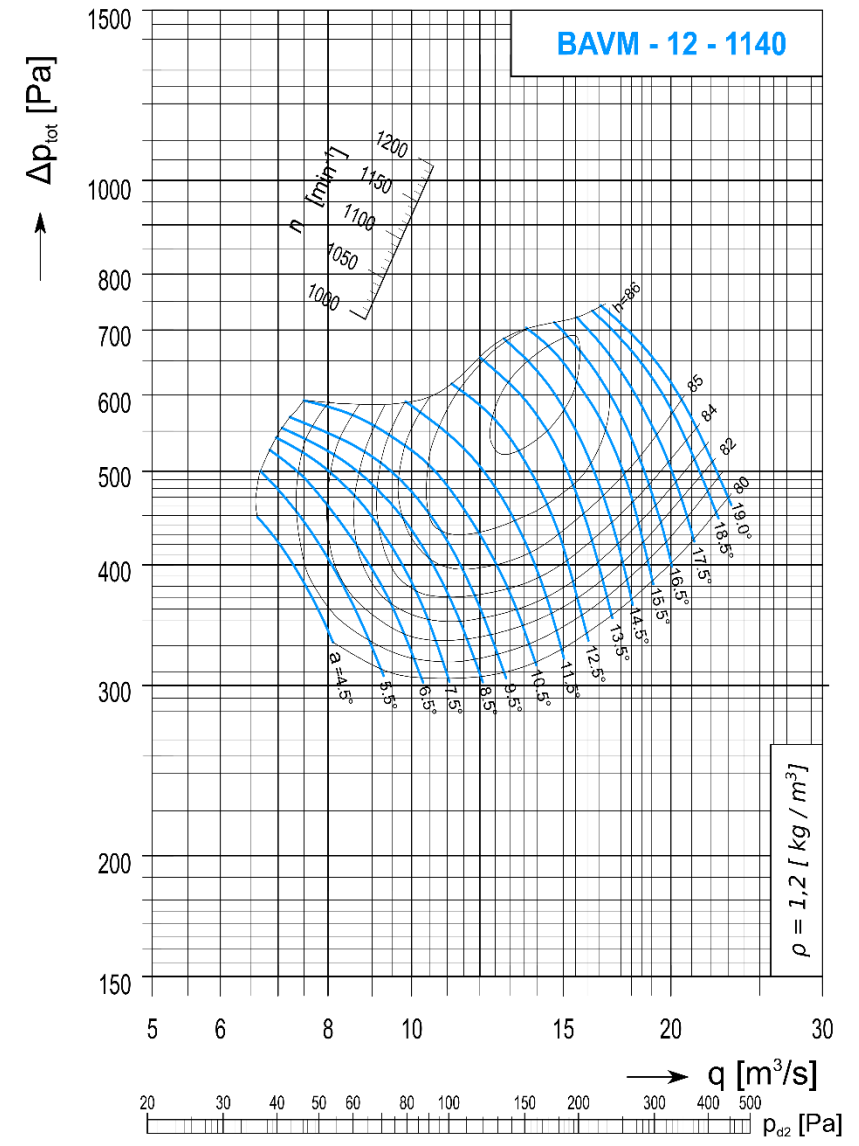
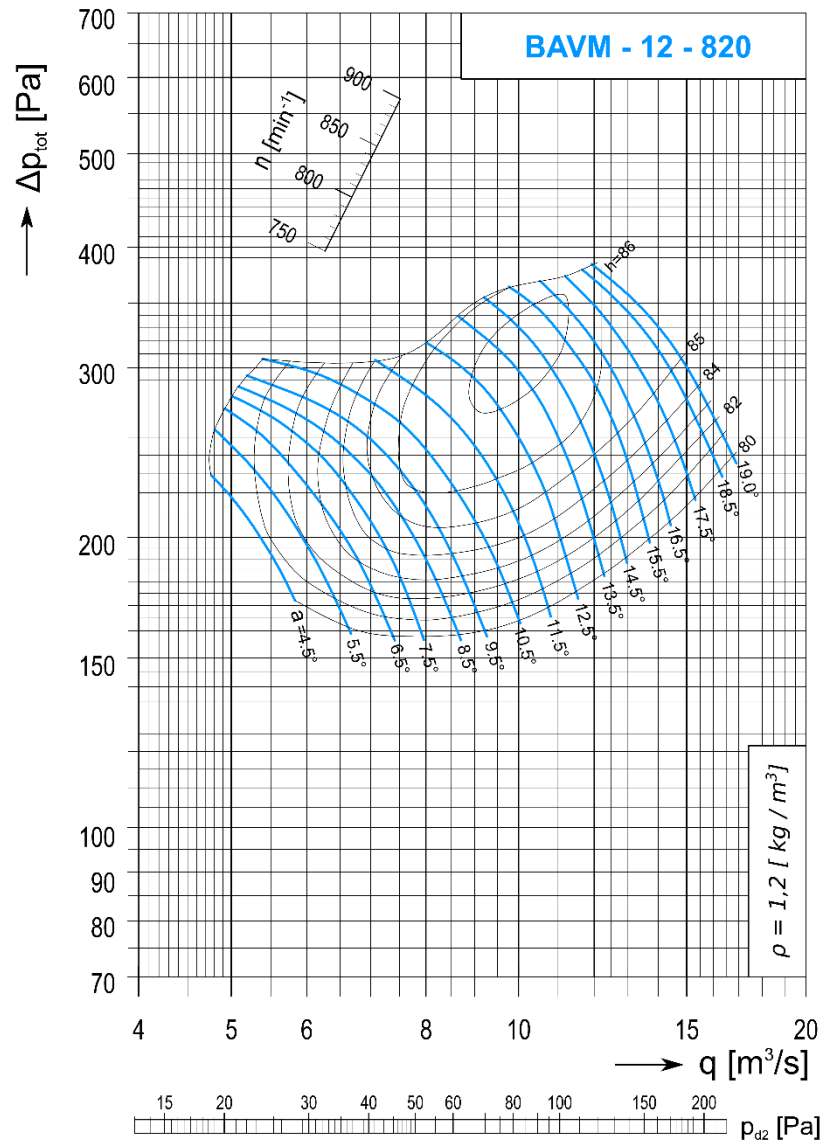



# (B)AVM ventilatori

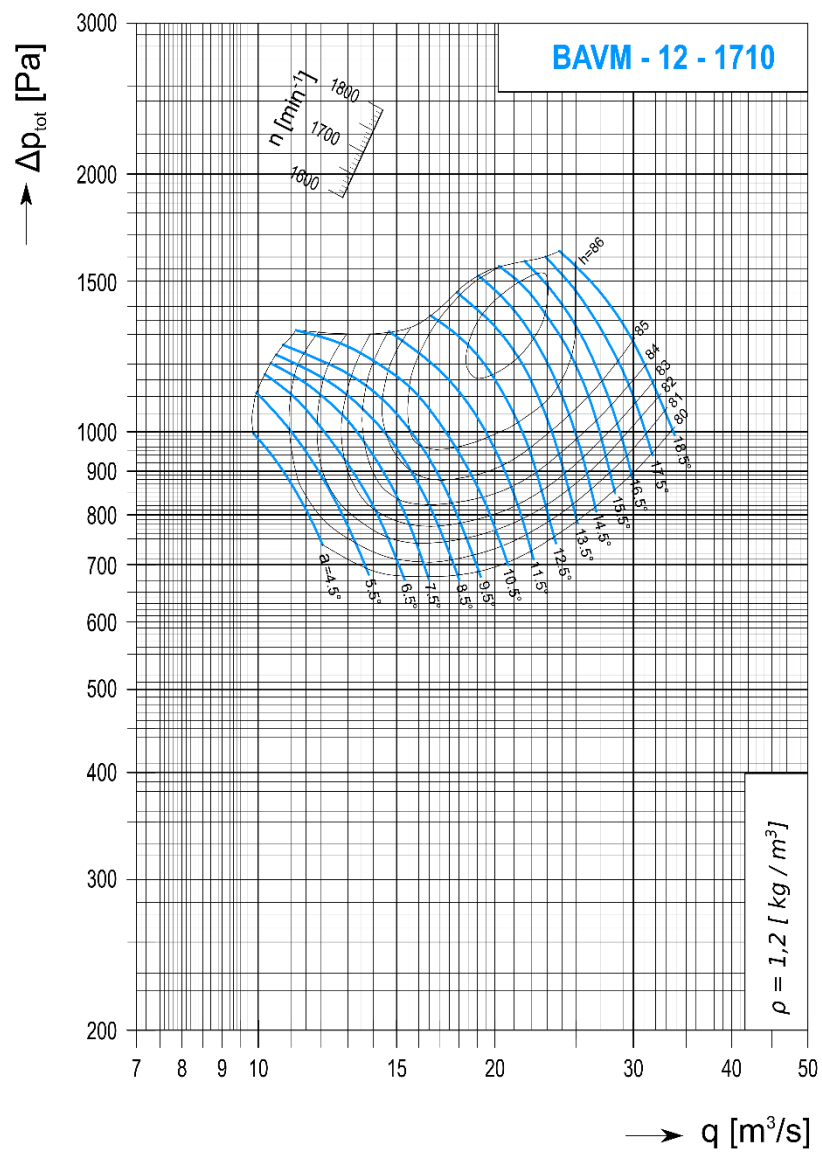

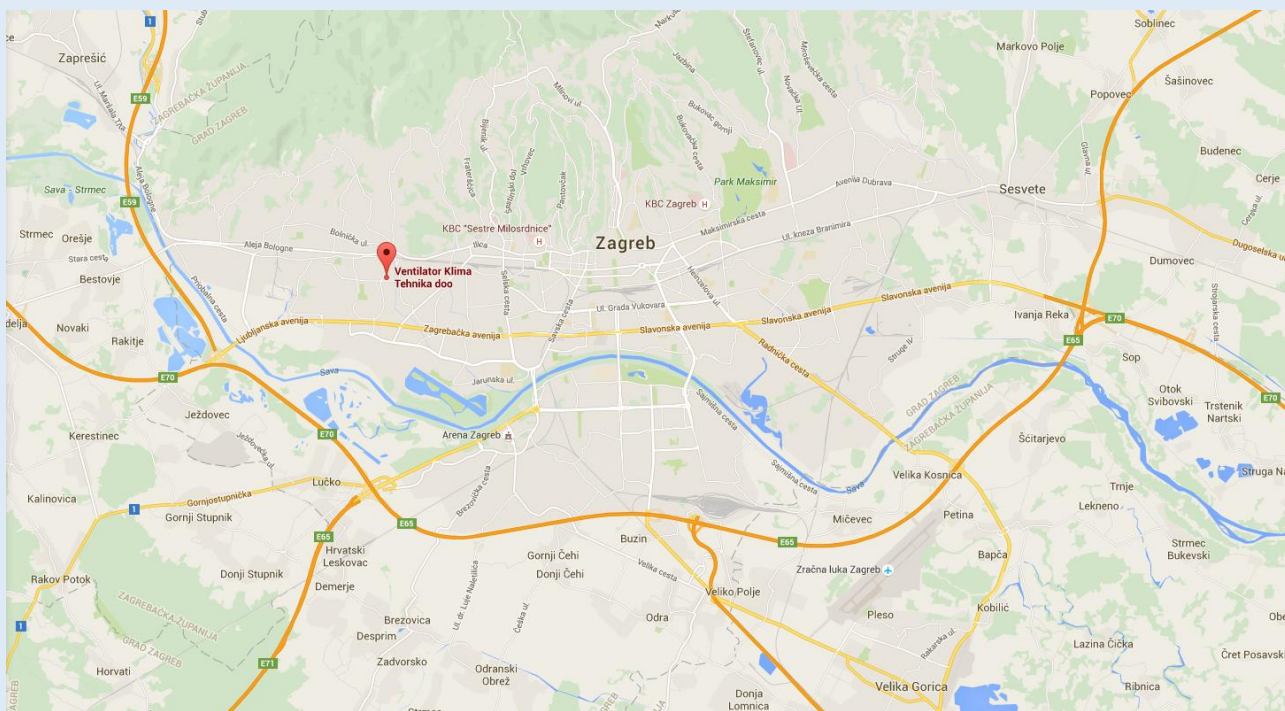



## VENTILATOR KLIMA TEHNIKA d.o.o.

Predstavništvo u Zagrebu:

 Zvonimira Furtingera 1a,  
HR-10000 Zagreb,  
Hrvatska

 Tel.: +385 1 3091 031

 Fax.: +385 1 3091 049

 E-mail: [info@ventilator-klimatehnika.hr](mailto:info@ventilator-klimatehnika.hr)

 Web: [www.ventilator-klimatehnika.hr](http://www.ventilator-klimatehnika.hr)

